

Quick Use Guide

MAGNAVOX

SMART. VERY SMART.

Printed in China

MRD300



First connect ...

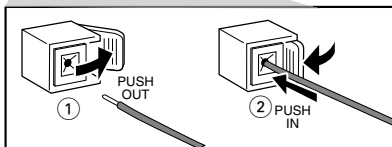
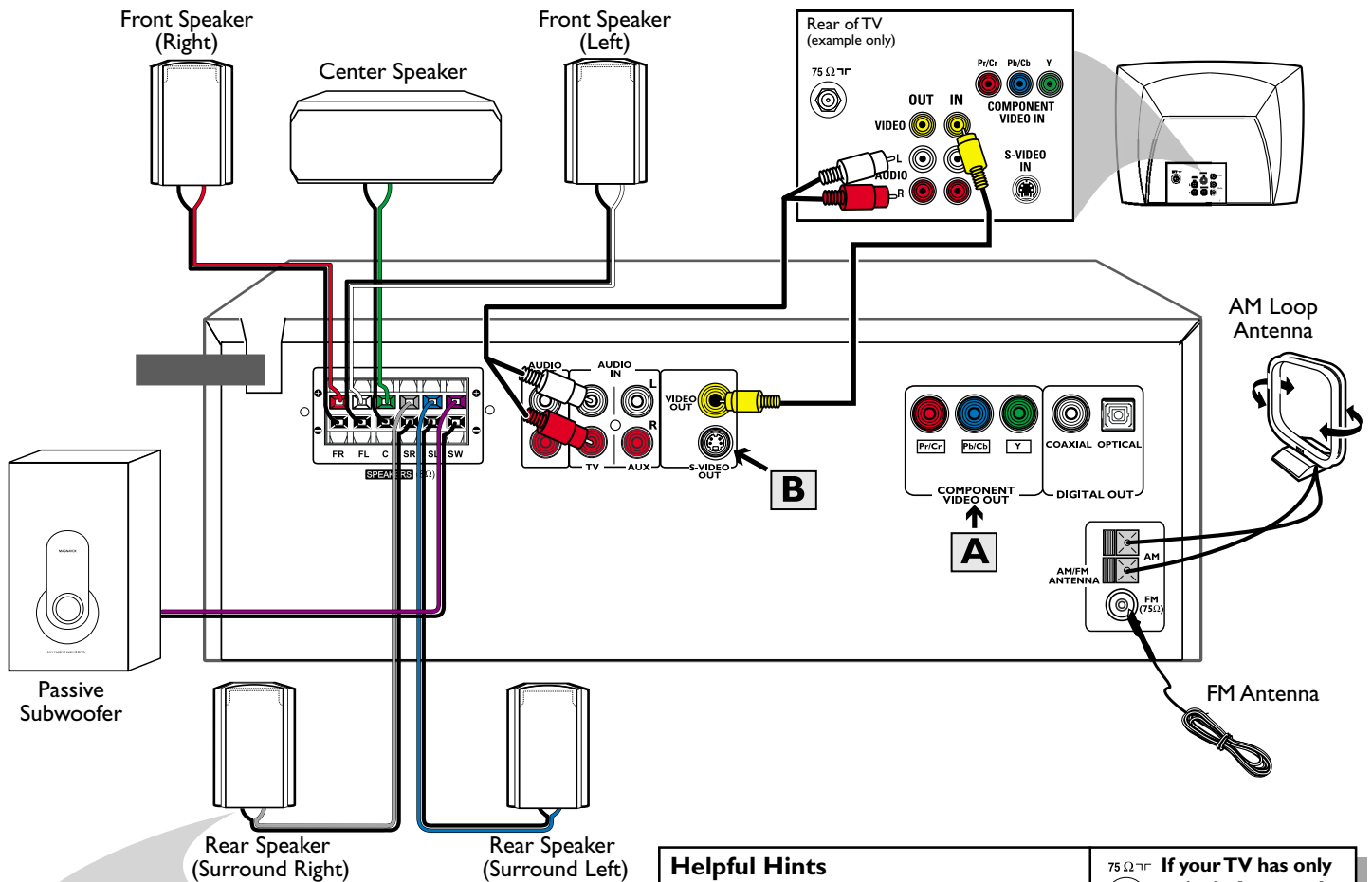

Connecting Speaker Cable

... then play
(see next page)

Helpful Hints

To obtain a better picture quality effect, you can choose to connect an extra video connection if your TV has the same input connector: [A] or [B].

	Use this video cable(s)	If your TV has this video input jack(s)
A		COMPONENT VIDEO IN
B	not supplied	S-VIDEO IN

75 Ω RF ANTENNA IN If your TV has only a single Antenna In jack, you will need an accessory RF modulator. The RF modulator converts the video from the DVD system so it can play through the TV's Antenna connector. Refer to your owner's manual for proper connection (refer to page 9 in the owner's manual.)

When listening to TV programs, press TV•AUX button at the front panel of the DVD system to select 'AUDIO IN-TV' in order for the sound to be heard.

For connecting to a VCR, see page 9 in the owner's manual for more details.

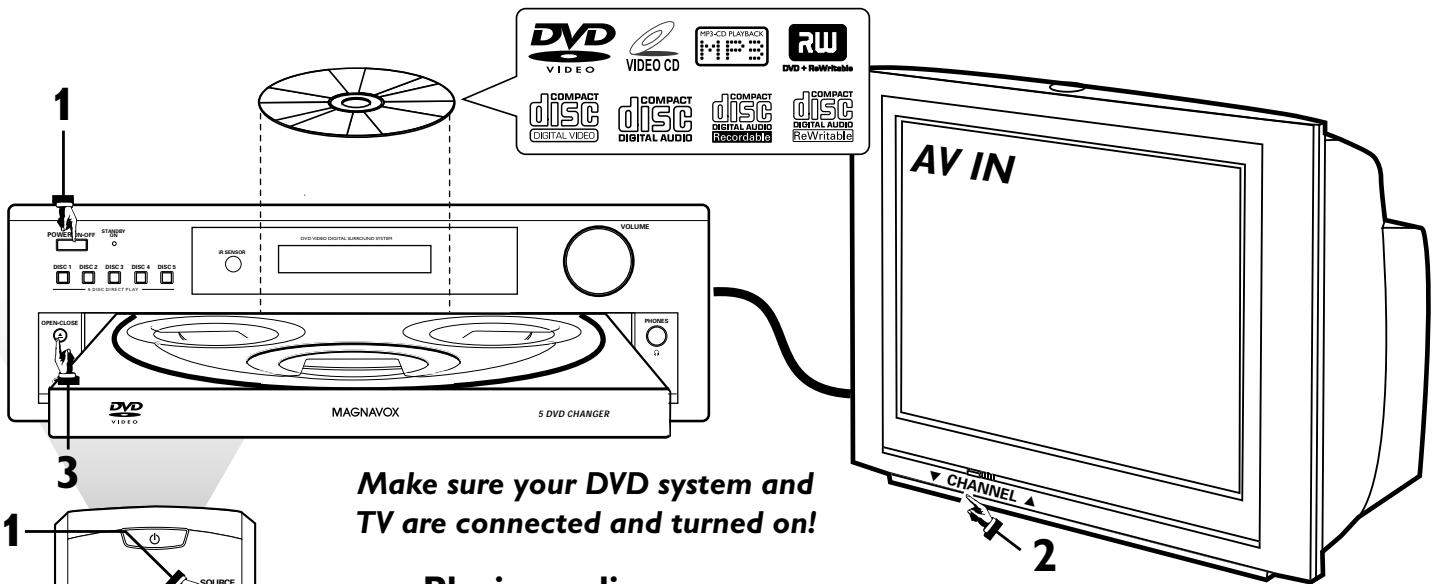

Make sure your DVD system and TV are connected and turned on!

Playing a disc

- 1 Press POWER ON•OFF at the front panel to turn the power on.**
You can also press the SOURCE button on the remote until "DISC X" appears on the display panel.
- 2 Turn on the TV and select the correct Video In mode.**
You should see the blue Philips DVD background screen on the TV (if no disc in the DVD system).
- 3 Press OPEN•CLOSE ▲ at the front panel of the DVD system and load a disc, then press the OPEN•CLOSE ▲ again to close the disc tray.**
Make sure the disc label is facing up. For double-sided discs, load the side you want to play face up.
- 4 Playback will start automatically. If not, press ►|| button.**
If a disc menu appears, use ▲▼◀▶ buttons on the remote to make the necessary selection, then press OK to confirm. Or, use the numeric keypad on the remote to select features. Follow the instructions given in the disc menu.
- 5 To stop playback, press STOP ■.**

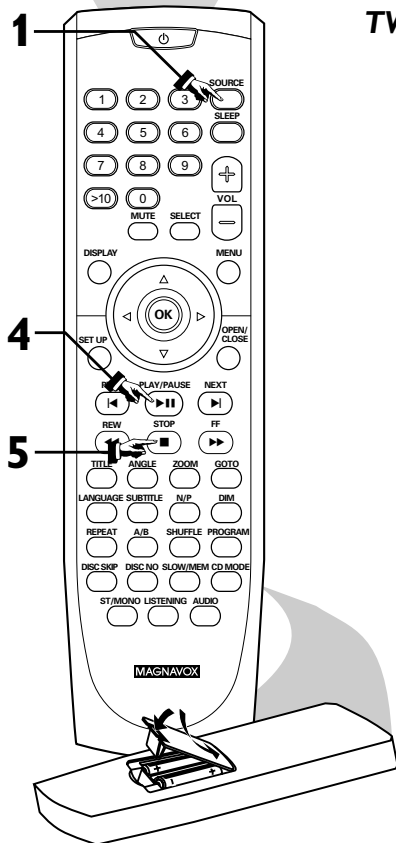

Region Codes

DVDs must be labeled for ALL regions or Region 1, in order to play on this DVD system.



No picture!!

Check the AV (Audio/Video) mode on your TV.

- * Usually this channel is between the lowest and highest channels and may be called FRONT, AV IN, or VIDEO.
- * Or, you may go to channel 1 on your TV, then press the Channel down button repeatedly until you see the Video In channel.
- * Or, your TV remote control may have a button or switch that chooses different video modes.
- * Do not use channel 3 or 4 on the TV unless you are using an RF modulator.
- * See your TV manual for more details.

DVD system Video Output Selection for Proper Playback

- 1) Press SETUP button.**
The Setup Menu main page appears on the TV screen.
- 2) Select 'GENERAL SETUP,' then press OK.**
- 3) Press ▼ button to select 'VIDEO OUT,' then press ► button.**
- 4) Press ▲ / ▼ button to select and highlight: S-VIDEO - if you use the S-Video connection.
CR CB Y - if you use the Component Video Pr/Cr Pb/Cb Y connection.**
- 5) Press OK button to confirm.**
The SETUP button to clear the screen when completed.

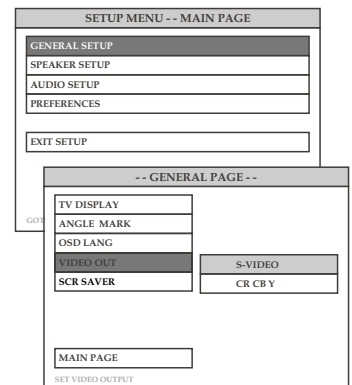

Note: If you have problem access to the Setup Menu, use the VIDEO OUT for connecting the DVD system to your TV (VIDEO IN). This connection enables you to access to the SETUP MENU and make the selection for the type of video output (S-VIDEO or CR CB Y).



Detailed playback features and additional functions are described in the accompanying owner's manual.

User guide

MAGNAVOX
SMART. VERY SMART.

MRD300 DVD VIDEO DIGITAL SURROUND SYSTEM



Need help? Call us!

Magnavox representatives are ready to help you with any questions about your new product. We can guide you through Connections, First-time Setup, or any of the Features. We want you to start enjoying your new product right away!

**CALL US BEFORE YOU CONSIDER
RETURNING THE PRODUCT!**

1-800-705-2000

or

Visit us on the web at www.magnavox.com



Return your Warranty Registration card today to ensure you receive all the benefits you're entitled to.

- Once your Magnavox purchase is registered, you're eligible to receive all the privileges of owning a Magnavox product.
- So complete and return the Warranty Registration Card enclosed with your purchase at once, and take advantage of these important benefits.

Warranty Verification

Registering your product within 10 days confirms your right to maximum protection under the terms and conditions of your Magnavox warranty.

Owner Confirmation

Your completed Warranty Registration Card serves as verification of ownership in the event of product theft or loss.

Model Registration

Returning your Warranty Registration Card right away guarantees you'll receive all the information and special offers which you qualify for as the owner of your model.

MAGNAVOX

Congratulations on your purchase, and welcome to the "family!"

Dear Magnavox product owner:

Thank you for your confidence in Magnavox. You've selected one of the best-built, best-backed products available today. And we'll do everything in our power to keep you happy with your purchase for many years to come.

As a member of the Magnavox "family," you're entitled to protection by one of the most comprehensive warranties and outstanding service networks in the industry.

What's more, your purchase guarantees you'll receive all the information and special offers for which you qualify, plus easy access to accessories from our convenient home shopping network.

And most importantly you can count on our uncompromising commitment to your total satisfaction.

All of this is our way of saying welcome – and thanks for investing in a Magnavox product.

Sincerely,



Lawrence J. Blanford
President and Chief Executive Officer

P.S. Remember, to get the most from your Magnavox product, you must return your Warranty Registration Card within 10 days. So please mail it to us right now!



Know these *safety* symbols



This "bolt of lightning" indicates uninsulated material within your unit may cause an electrical shock. For the safety of everyone in your household, please do not remove product covering.



The "exclamation point" calls attention to features for which you should read the enclosed literature closely to prevent operating and maintenance problems.

WARNING: TO PREVENT FIRE OR SHOCK HAZARD, DO NOT EXPOSE THIS EQUIPMENT TO RAIN OR MOISTURE.

CAUTION: To prevent electric shock, match wide blade of plug to wide slot, and fully insert.

For Customer Use

Enter below the Serial No. which is located on the rear of the cabinet. Retain this information for future reference.

Model No. _____

Serial No. _____

English 6

Español 31

IMPORTANT SAFETY INSTRUCTIONS

1. Read these instructions.
2. Keep these instructions.
3. Heed all warnings.
4. Follow all instructions.
5. Do not use this apparatus near water.
6. Clean only with dry cloth.
7. Do not block any ventilation openings. Install in accordance with the manufacturer's instructions.
8. Do not install near any heat sources such as radiators, heat registers, stoves, or other apparatus (including amplifiers) that produce heat.
9. Do not defeat the safety purpose of the polarized or grounding-type plug. A polarized plug has two blades with one wider than the other. A grounding type plug has two blades and a third grounding prong. The wide blade or the third prong are provided for your safety. If the provided plug does not fit into your outlet, consult an electrician for replacement of the obsolete outlet.
10. Protect the power cord from being walked on or pinched, particularly at plugs, convenience receptacles, and the point where they exit from the apparatus.

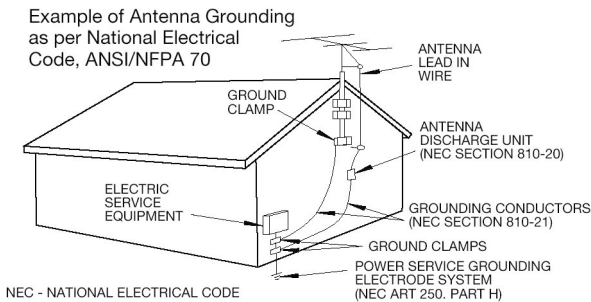
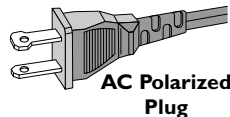

“NOTE TO CATV SYSTEM INSTALLER :
THIS REMINDER IS PROVIDED TO CABLE GROUND SHALL BE CONNECTED TO THE GROUNDING SYSTEM OF THE BUILDING, AS CLOSE TO THE POINT OF CABLE ENTRY AS PRACTICAL.”

11. Only use attachments/accessories specified by the manufacturer.
12.  Use only with the cart, stand, tripod, bracket, or table specified by the manufacturer or sold with the apparatus. When a cart is used, use caution when moving the cart/apparatus combination to avoid injury from tip-over.
13. Unplug this apparatus during lightning storms or when unused for long periods of time.
14. Refer all servicing to qualified service personnel. Servicing is required when the apparatus has been damaged in any way, such as power-supply cord or plug is damaged, liquid has been spilled or objects have fallen into the apparatus, the apparatus has been exposed to rain or moisture, does not operate normally, or has been dropped.
15. **Battery usage CAUTION** – To prevent battery leakage which may result in bodily injury, property damage, or damage to the unit:
 - Install **all** batteries correctly, **+** and **-** as marked on the unit.
 - Do not mix batteries (**old** and **new** or **carbon** and **alkaline**, etc.).
 - Remove batteries when the unit is not used for a long time.
16. This appliance shall not be exposed to dripping or splashing water and that no object filled with liquid such as vases shall be placed on the apparatus.
17. **Power Lines** – An outdoor antenna should be located away from power lines.
18. **Outdoor Antenna Grounding** – If an outside antenna is connected to the product, be sure that the antenna system is grounded so as to provide some protection against voltage surges and built up static charges. Section 810 of the National Electrical Code, ANSI/NFPA 70 provides information with respect proper grounding of the mast and supporting structure, grounding of the lead-in wire to an antenna discharge unit, size of grounding conductors, location of antenna-discharge unit, connection to grounding electrodes, and requirements for the grounding electrode. See Figure

Class II equipment symbol 

This symbol indicates that the unit has a double insulation system

Canada

English:

This digital apparatus does not exceed the Class B limits for radio noise emissions from digital apparatus as set out in the Radio Interference Regulations of the Canadian Department of Communications.

Manufactured under license from Dolby Laboratories. "Dolby", "Pro-Logic" and the double-D symbol are trademarks of Dolby Laboratories. Confidential Unpublished Works. ©1992-1999 Dolby Laboratories, Inc. All rights reserved.

This product incorporates copyright protection technology that is protected by method claims of certain U.S. patents and other intellectual property rights owned by Macrovision Corporation and other rights owners. Use of this copyright protection technology must be authorized by Macrovision Corporation, and is intended for home and other limited viewing uses only unless otherwise authorized by Macrovision Corporation. Reverse engineering or disassembly is prohibited.

Laser

Type	Semiconductor laser GaAlAs
Wave length	650nm
Output Power	7mW
Beam divergence	60 degree

The set complies with the FCC-Rules, Part 15 and with 21 CFR 1040.1. Operation is subject to the following two conditions:

- 1. This device may not cause harmful interference, and**
- 2. This device must accept any interference received, including interference that may cause undesired operation.**

NOTE:

PICTURES SHOWN MAY BE DIFFERENT BETWEEN COUNTRIES.

NEVER MAKE OR CHANGE CONNECTIONS WITH THE POWER SWITCHED ON.

CAUTION

Use of controls or adjustments or performance of procedures other than herein may result in hazardous radiation exposure or other unsafe operation.

ATENCIÓN

El uso de mando o ajustes o la ejecución de métodos que no sean los aquí descritos puede ocasionar peligro de exposición a radiación.

Contents

Introduction and General Information

Features	7
Supplied accessories	7
Environmental information.....	7
Installation	7
Maintenance.....	7

Connections

Step 1: Connecting antennas.....	8
AM Indoor Loop Antenna	8
FM Indoor Antenna	8
Step 2: Connecting the speakers and passive subwoofer	8
3. Connecting a TV	9
Connecting additional equipment.....	9
1) Listening to the playback of other equipment	9
2) Using the VCR for recording DVDs	9
3) Digital Recording (Coaxial or Optical)	9

Functional Overview

Front panel	10
Remote Control	11–12

Preparations

Inserting batteries into the remote control.....	13
Switching on the system	13
Setting up the surround sound system	13
Placing the speakers	13
Changing the speakers' sound level.....	14
Activating/Deactivating progressive scan mode	14
System Setup (DVD)	14
Selecting the color system that matches the connected TV	14
Selecting the type of video output	15
Selecting the On Screen Display (OSD) language.....	15
Changing the TV display	15
Selecting the language for Audio/Subtitle/Disc Menu	16
Changing and testing the speakers setting.....	16
Setting the digital output	16
Changing the sound channel	17
Balancing the volume level through setting the dynamic range	17
Activating the camera angle indication	17
Activating screen saver	17
Restoring the original settings	17
Setting the parental control level	18
Changing the parental control password	18

Disc Operations

Discs information	19
Disc playback	19
Basic playback controls	19–20
Resuming playback from the last stopped point (DVD only).....	20
Repeat play mode	20
Repeat playback a specific section/passage continuously ..	20
Fast searching for a particular passage	20
Special DVD/VCD features	20
Using the DVD title menu	20
Using the DVD root menu	20
Changing the audio/subtitle language for the current disc only	21
Viewing from another angle	21
Searching for a particular title, chapter or elapsed time ...	21
Zooming in.....	21
Playing in slow motion mode	21
Using the Playback Control (PBC) feature (VCD only)	21
Special CD features	21
Playing CDs only	21
Shuffle play mode.....	22
Program favorite tracks	22
Playing MP3/Picture disc (Kodak, JPEG)	22
Supported MP3 format	22

Radio Reception

Tuning to radio stations	23
Presetting radio stations	23
Listening to preset radio stations	23

Other Functions

Volume control	24
Adjusting the speakers' tones and channels	24
Dimming the display screen	24
Selecting Listening mode	24
Sleep timer setting	24

Specifications

Troubleshooting

Glossary

Limited Warranty.....

Features

Your complete 7-piece 300-Watt DVD Digital Home Cinema System creates the same dynamic sound qualities that you find in full-fledged cinemas and incorporates some of the best features in home theater technology.

Features include:

Built-in Dolby® Digital decoder, supporting Dolby® ProLogic

Use the Home Cinema Audio System for a movie-theater surround sound experience.

Additional Component Connections

Connect other audio and audio/visual equipments to the DVD system so you can use the system's surround sound speakers.

Night Mode

Compress the dynamic range, reduce the differences in the loudness of sound outputs. You are able to play the disc at the same volume level without disturbing others.

Parental Control (Rating Level)

Set a ratings level so your children cannot watch a DVD that has a rating higher than you set.

Sleep Timer

Enable the system to switch to standby mode automatically at a preset time.

Progressive Scan

Provides a flicker free image with the highest effect on film based sources. It can double the vertical resolution of the picture to 525 lines every time the picture is refreshed. **To enjoy the full quality potential offered by progressive scan feature, a progressive scan TV is required.**

Supplied accessories

- Remote control with two AAA batteries
- AM loop antenna and FM wire antenna
- Audio cable (white/red)
- Composite video cable (yellow)
- Component video cables (red/blue/green)
- Five satellite speakers, including five speaker cables
- Passive subwoofer, including cable
- This instruction booklet and Quick Use Guide

If any item is damaged or missing, contact your retailer.

Environmental information

All unnecessary packaging has been omitted. We have tried to make the packaging easy to separate into three materials: cardboard (box), polystyrene foam (buffer) and polyethylene (bags, protective foam sheet.)

Your system consists of materials which can be recycled and reused if disassembled by a specialized company. Please observe the local regulations regarding the disposal of packaging materials, exhausted batteries and old equipment.

Installation

- Place the player on a flat, hard, and stable surface.
- There must be sufficient room in front of the player for the drawer to open.
- In a cabinet, allows about 10cm (4 inches) of free space all around the player for adequate ventilation.
- Do not expose your player to extreme temperatures or humidity.

Maintenance

- When a disc becomes dirty, clean it with a cleaning cloth. Wipe the disc from the center out, in a straight line.
- Do not expose the player, batteries or discs to humidity, rain, sand or excessive heat (caused by heating equipment or direct sunlight.) Always keep the disc tray closed to avoid dust on the lens.
- Do not use solvents such as benzene, thinner, commercially available cleaners, or anti-static spray intended for analog discs.
- The lens may cloud over when the player is suddenly moved from cold to warm surroundings, making it impossible to play a disc. Leave the player in the warm environment until the moisture evaporates.

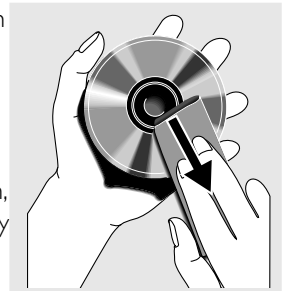

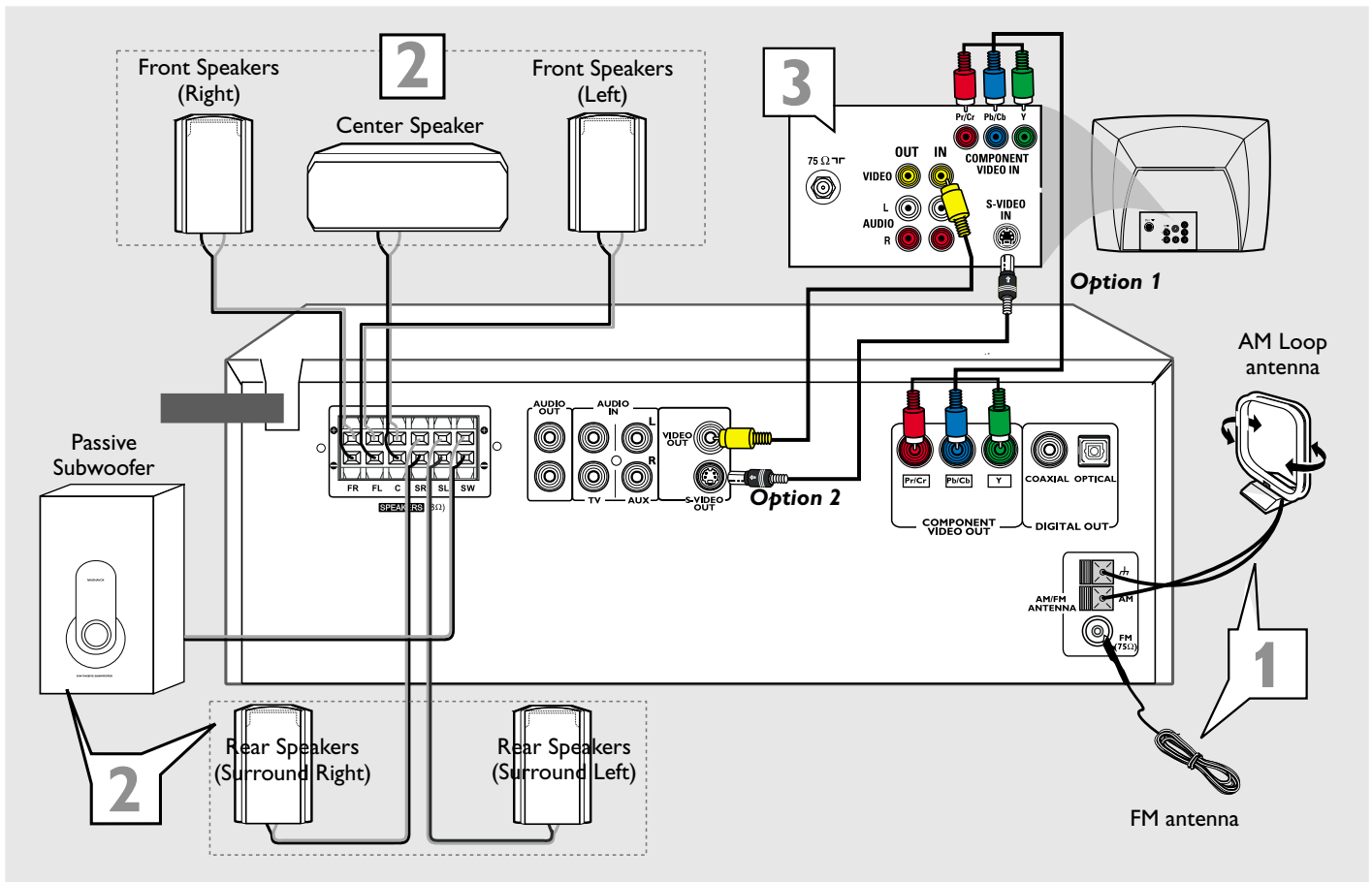

IMPORTANT!

- Before connecting the AC power cord to the wall outlet, ensure that all other connections have been made.
- Never make or change any connections with the power switched on.
- The type plate is located at the rear or bottom of the system.

Step 1: Connecting antennas

AM Indoor Loop Antenna

Use the supplied AM loop antenna, connect the black wire to the **AM** jack marked "A" and the red wire to another jack. Place the antenna on a shelf or attach it to a stand or wall.

FM Indoor Antenna

Connect the supplied FM antenna to the **FM (75Ω)** jack. Extend the FM antenna and fix its ends to the wall.

For better FM stereo reception, connect an external FM antenna using an 75 ohm coaxial cable (not supplied).

Helpful Hints:

- Adjust the position of the antennas for optimal reception.
- Position the antennas as far as possible from your TV, VCR or other radiation source to prevent unwanted interference.

Step 2: Connecting the speakers and passive subwoofer

Connect the supplied speaker systems and passive subwoofer using the supplied speaker cables by matching the colors of the jacks and speaker cables.

- Press up (or down) the speaker's jack and fully insert the stripped portion of the speaker cable into the jack, then release.

Speakers	⊖	⊕
Front Left (FL)	black	white
Front Right (FR)	black	red
Center (C)	black	green
Surround Left (SL)	black	blue
Surround Right (SR)	black	gray
Subwoofer (SUBW)	black	purple

Helpful Hints:

- Ensure that the speaker cables are correctly connected. Improper connections may damage the system due to short-circuit.
- For optimal sound performance, use the supplied speakers.
- Do not connect more than one speaker to any one pair of + / - speaker jacks.
- Do not connect speakers with an impedance lower than the speakers supplied. Please refer to the SPECIFICATIONS section of this manual.

Step 3: Connecting a TV

IMPORTANT!

- There are various ways to connect the system to a TV (as shown in the illustration,) it depends on the capabilities of your TV system.
- The progressive scan video quality is only possible through Pr/Cr Pb/CbY output and a progressive scan TV is required.

● To view the DVD playback

Use the video cable (yellow) to connect the system's **VIDEO OUT** jack to the video input jack on the TV.

● You can make an extra video connection with one of the following options if your TV has the same input connector

Option 1

1 Use the component video cables (red/blue/green) to connect the system's **Pr/Cr Pb/Cb Y** jacks to the corresponding Pr/Cr Pb/Cb Y input jacks on the TV.

2 If you are using a **Progressive Scan TV** (TV must indicate Progressive Scan or ProScan capability,) press and hold the **PROGRESSIVE SCAN-DVD** button (located at the front panel) for more than two seconds to switch on the progressive scan mode.

→ 'P-SCAN' icon will appear on the display panel.

OR

Option 2

Use the S-video cable (not supplied) to connect the system's **S-VIDEO OUT** jack to the S-Video input jack on the TV.

IMPORTANT!

If **S-VIDEO** or **Component video Pr/Cr Pb/Cb Y** is used for DVD playback connection, the DVD system's **VIDEO OUT** setting will need to be set accordingly. Details are on page 15.

● If your TV only has an RF-style jack (Antenna In or 75 ohm)

You will need an RF modulator in order to view the playback of DVD discs on your TV. Ask your dealer for details on RF modulator availability and compatibility. Follow the instructions provided with the RF modulator to connect the DVD system to your TV.

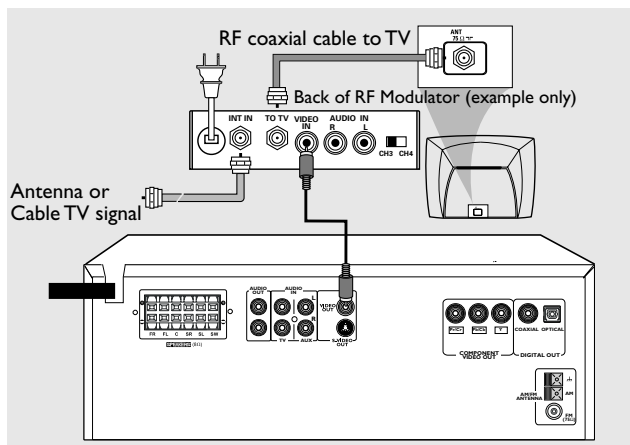

Connecting additional equipment

IMPORTANT!

- Some DVDs are copy-protected. You cannot record the disc through a VCR or digital recording device.
- When making connections, make sure the color of cables matches the color of jacks.
- Always refer to the owner's manual of the other equipment for complete connection and usage details.

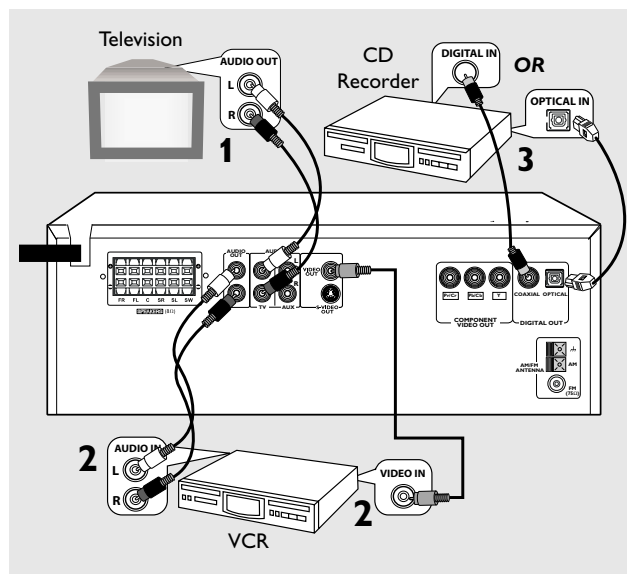

1) Listening to the playback of other equipment

Connect the system's **AUDIO IN (TV or AUX)** jacks to the **AUDIO OUT** jacks on the other audio/visual device (such as a TV, VCR, Laser Disc player or cassette deck).

Before starting operation, press **TV•AUX** at the front panel to select "AUDIO IN-TV" or "AUDIO IN-AUX" in order to activate the input source.

2) Using the VCR for recording DVDs

Connect the system's **VIDEO OUT** jacks to the **VIDEO IN** jacks and **AUDIO OUT** jacks to the **AUDIO IN** jacks on the VCR. This will allow you to make analog stereo (two channel, right and left) recordings.

3) Digital Recording (Coaxial or Optical)





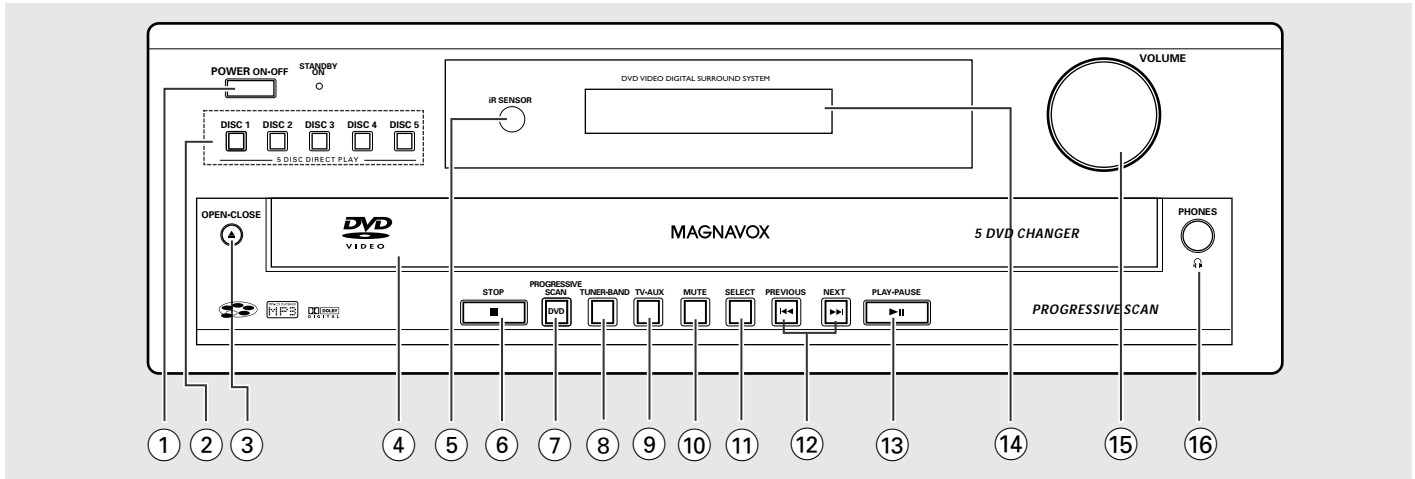

Connect the system's **DIGITAL OUT-COAXIAL** jack to the **DIGITAL COAXIAL IN** jack (or **DIGITAL OUT-OPTICAL** to **DIGITAL OPTICAL IN**) on a digital recording device (such as Dolby Digital decoder, CD recorder).

Before starting operation, set the **DIGITAL OUTPUT** according to the audio connection. (See page 16.)

Functional Overview

Front panel



- ① **POWER ON•OFF** 
 - to switch between power on and standby modes.
- ② **5 DISC DIRECT PLAY (DISC 1~5)**
 - to select a disc for playback.
- ③ **OPEN•CLOSE**  (in Disc mode only)
 - to open or close the disc tray.
- ④ **Disc carousel tray**
- ⑤ **IR SENSOR**
 - receives signals from the remote control.
- ⑥ **STOP**  (in Disc mode only)
 - to stop playing the disc.
- ⑦ **DVD (PROGRESSIVE SCAN)**
 - to select DVD/CD mode.
 - press and hold to switch between Progressive Scan on and off.
- ⑧ **TUNER•BAND**
 - to select TUNER (FM or AM) mode.
- ⑨ **TV•AUX**
 - to select TV or AUX mode.
- ⑩ **MUTE**
 - to interrupt or resume sound reproduction.
- ⑪ **SELECT**
 - to select the respective speaker channel, then use the VOLUME button to adjust its sound level.
- ⑫ **PREVIOUS**  / **NEXT** 
 - in Disc mode, press to skip to the previous/next chapter/track.
 - in Tuner mode, to tune to a lower or higher radio frequency.
- ⑬ **PLAY•PAUSE**  (in Disc mode only)
 - to start or interrupt disc playback.
- ⑭ **Display screen**
 - to display details for user's information.
- ⑮ **VOLUME**
 - to adjust the master volume.
- ⑯ **PHONES** 
 - to connect headphones.

The same functions can be accessed via the same buttons on the remote control (see next page)

Remote Control

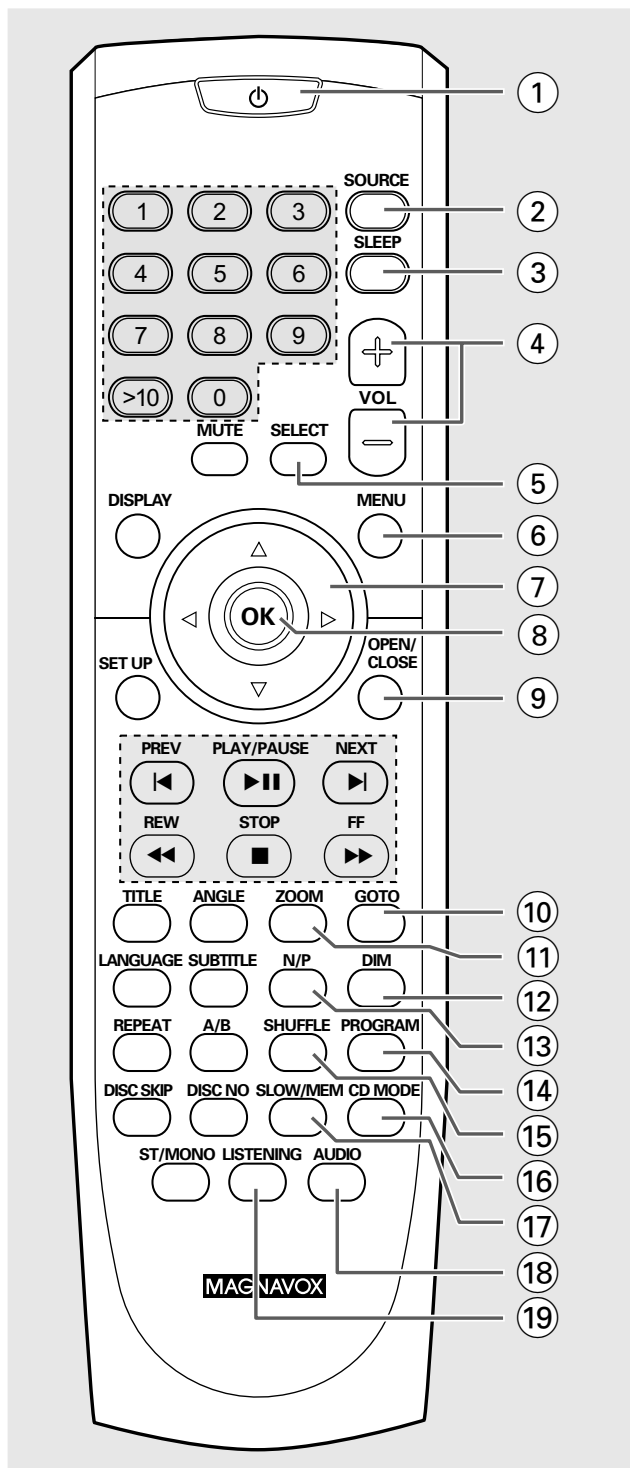

Notes for remote control:

- While the system is in active mode, select the source you wish to control by pressing **SOURCE** key on the remote control.
- Then select the desired function (▶||, ◀◀, ▶▶, for example).

- ① **⏻**
 - to switch between power on and standby modes.
- ② **SOURCE**
 - to select the desired source (DVD/CD, TUNER (FM), TUNER (AM), TV or AUX.)
- ③ **SLEEP**
 - to set the sleep (auto-off) timer function.
- ④ **VOL + –**
 - to adjust the master volume.
- ⑤ **SELECT**
 - to select the respective speaker channel, then use the VOLUME button to adjust its sound level.
- ⑥ **MENU**
 - to enter or exit the disc contents menu.
 - to switch on or off the playback control mode (for VCD version 2.0 and MP3.)
- ⑦ **▲▼◀▶**
 - to select movement direction in disc contents menu / system menu bar.
- ⑧ **OK**
 - to enter or confirm the selection.
- ⑨ **OPEN/CLOSE** (in Disc mode only)
 - to open or close the disc tray.
- ⑩ **GOTO**
 - to playback at any chosen time on the disc.
- ⑪ **ZOOM**
 - to enlarge a picture on the TV screen.
- ⑫ **DIM**
 - to select a different brightness for the display screen.
- ⑬ **N/P**
 - to change the color system (NTSC/PAL/MULTI) temporarily without changing the default setting.
- ⑭ **PROGRAM**
 - to program disc tracks.
- ⑮ **SHUFFLE**
 - to play CD tracks in random order.
- ⑯ **CD MODE**
 - to start or cancel playback all available audio CDs in the disc carousel tray.
- ⑰ **SLOW/MEM**
 - in Disc mode, to watch a disc at a slower speed.
 - in Tuner mode, to program preset radio stations.
- ⑱ **AUDIO**
 - to select the audio channel for sound.
- ⑲ **LISTENING**
 - to select a desired listening mode (surround/stereo/ sound effects.)

- ⑳ **Numeric Keypad (0-9, >10)**
- to enter a track/title number of the disc.
 - to enter a number of preset radio stations.
- ㉑ **MUTE**
- to interrupt or resume sound reproduction.
- ㉒ **DISPLAY**
- to switch on or off the On Screen Display on the TV.
- ㉓ **SETUP** (in DVD mode only)
- to enter or exit the system setup menu.
- ㉔ **PREV ◀ / NEXT ▶**
- in Disc mode, to skip to the previous/next chapter/track.
 - in Tuner mode, to tune to a lower or higher radio frequency.
- REW ◀◀ / FF ▶▶**
- in Disc mode, to fast reverse/forward the disc.
 - in Tuner mode, to select a preset radio station number.
- PLAY/PAUSE ▶◻◻** (in Disc mode only)
- to start or interrupt disc playback.
- STOP ◻** (in Disc mode only)
- to stop playing the disc.
- ㉕ **TITLE**
- to display the Title menu if present on the DVDs.
- ㉖ **ANGLE**
- to select a camera angle available in the DVDs.
- ㉗ **LANGUAGE**
- to select different audio languages available in the DVDs.
- ㉘ **SUBTITLE**
- to select different subtitle languages available in the DVDs.
- ㉙ **REPEAT**
- to repeat chapter, track or disc.
- ㉚ **A-B**
- to repeat a specific section on a disc.
- ㉛ **DISC SKIP**
- to select another disc tray for playback.
- ㉜ **DISC NO**
- to display the active disc number.
- ㉝ **ST/MONO**
- to switch between Monaural and stereo mode during FM stereo reception.

Remote Control

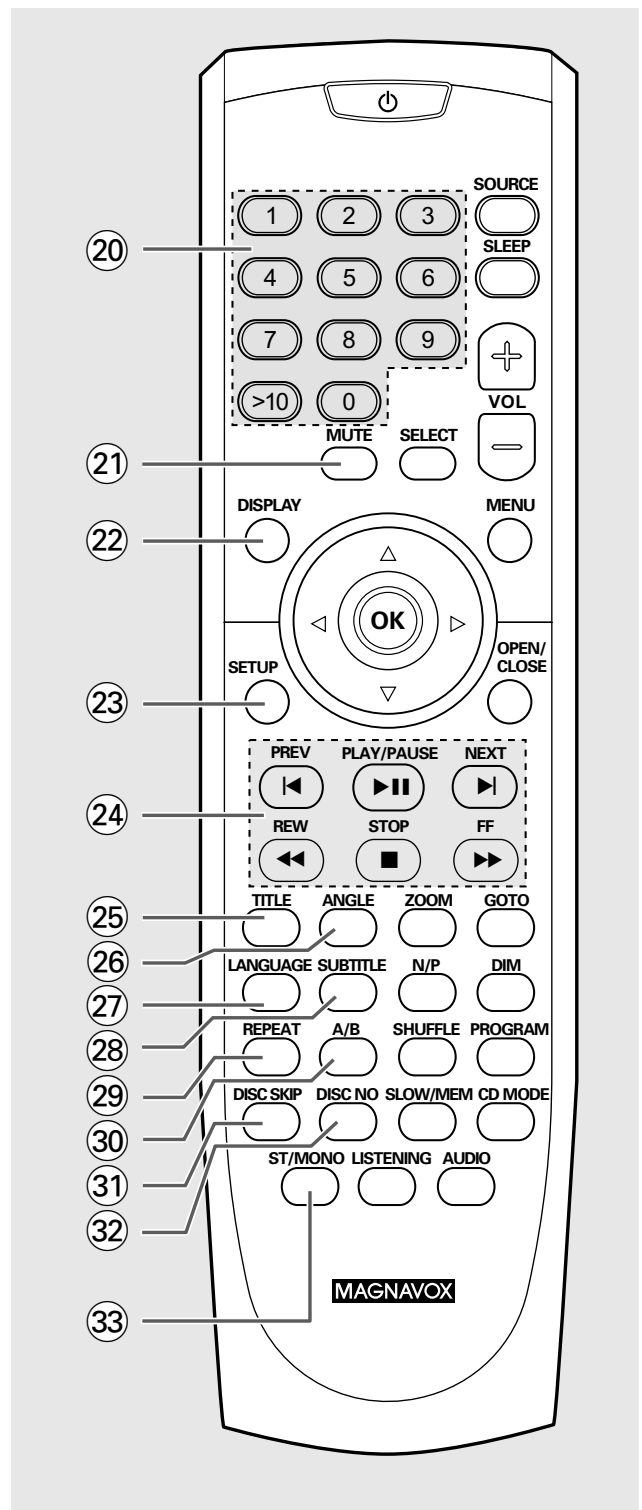

Inserting batteries into the remote control

- 1 Open the battery compartment.
- 2 Place the batteries in the compartment with the correct polarity as indicated by “+” and “-” symbols.
- 3 Close the cover.

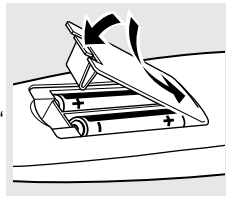

CAUTION!

- Remove batteries if they are exhausted or will not be used for a long time.
- Do not use old and new or different types of batteries in combination.
- Batteries contain chemical substances, so they should be disposed of properly.

Switching on the system

- 1 After completing all the connections, connect the AC power cord of the DVD system to the active power outlet.
 - 2 Press **POWER ON/OFF** ϕ to turn on the DVD system.
 - 3 Press **DVD, TUNER/BAND** or **TV/AUX** (or press **SOURCE** on the remote control) to select the input source.
 - The selected source will be displayed.
- **For viewing a DVD or VCD disc, a TV set needs to be connected** (refer to “Connections - Connecting a TV”).
- Switch on the TV and set to the correct video in channel (for example, EXT1, EXT2, AV1, AV2.) Refer to your TV instruction manual for details.
- The default screen appears on the TV.

IMPORTANT!

- If you do not get a proper picture or sound, please refer to “System Setup (DVD)” in order to change the pre-settings as necessary to accommodate your TV system or change to your preferred settings.
- If you get a completely distorted or black and white picture, it might be because you are using a PAL TV or NTSC TV. Press N/P button on the remote control to change between PAL and NTSC in order to match the color system of your TV. To change the default setting, go to “System Menu” and change the “TV TYPE”, details are on next page.

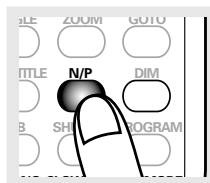

Setting up the surround sound system

You must connect all the speakers and set up the system properly in order to enjoy the Digital Cinema experience at home (refer to “Connections - Connecting the speakers and passive subwoofer”). You will have the feeling of being in the middle of the action because sound is coming from everywhere around you. The subwoofer can enhance the bass performance of your system dramatically.

IMPORTANT!

Please sit at your usual listening position in order to set up the speaker balance correctly.

Placing the speakers

To obtain the best surround effect, place the speakers as follows.

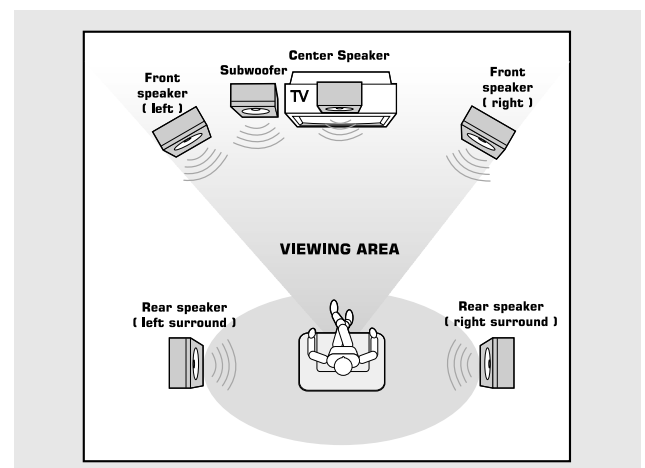

- 1 Place the front left and right speakers at equal distances from the TV and at an angle of approximately 45 degrees from the listening position.
- 2 Place the center speaker above or below the TV so the center channel's sound is localized.
- 3 Place the surround speakers at normal listening ear level facing each other or mounted on the wall.
- 4 Place the subwoofer on the floor near the TV.

Helpful Hints:

- To avoid magnetic interference, do not position the front speakers too close to your TV.
- If the rear surround speakers are installed farther away from the listening position than the front and center speakers, it will weaken the surround effect.
- All speakers should be securely installed to prevent accidents and improve sound quality.

Changing the speakers' sound level

You can change the speakers' sound distribution to suit your surround sound needs. For example, if you are close to the left front speaker than the right front speaker, the left front speaker might seem "louder" than the right one. To adjust it, you must change the channel level for one or both speakers until the sound evens out.

- 1 Press **DVD** to switch on to DVD mode.
- 2 Press **SELECT** to select a speaker (front left, center, front right, surround right, surround left or subwoofer.)
- 3 Adjust **VOLUME** (or press **VOL + -** on the remote control) to change the channel level.
FL, CNT, FR, SR, SL or Subwoofer: - 15 to + 10,
- 4 Repeat **steps 2-3** for other setting.

Activating/Deactivating progressive scan mode

The progressive-scan display presents 60 complete frames per second, rather than the 30 frames per second of interlaced scanning (ordinary normal TV system.) With nearly double the numbers of line, progressive scan offers higher picture resolution and eliminates bothersome motion artifacts those jagged edges on moving objects.

To enjoy the full quality potential offered by progressive scan feature, a progressive scan TV is required.

- 1 Press **DVD** to switch on to DVD mode.
- 2 Press and hold **DVD (PROGRESSIVE SCAN)** again for more than two seconds to switch on/off progressive scan mode.
→ 'P-SCAN' icon will appear on the display panel if progressive scan mode is active.

Helpful Hints:

- The progressive scan video quality is only possible through Pr/Cr Pb/CbY video output connection.
- Ensure that you have changed the type of video output setting to 'PR PB Y' in the system setup menu (see next page).

System Setup (DVD)

The system setup is carried out via the TV, it enabling you to customize the DVD system to suit your particular requirement. If the preferred options selected are not available on a disc, then the discs own preference will be used.

IMPORTANT !

- To access the System Setup menu, playback must be stopped.
- Some operations may be different or restricted, depending on the disc format. Refer to the jacket or case of the disc you are playing.

Selecting the color system that matches the connected TV

DVDs are recorded according to a color system, the most common of which are NTSC and PAL. NTSC is the most common in the United States. In order for a DVD to play on this DVD system, the color system of the DVD, the TV and the DVD system should match.

- 1 Press **SETUP**.
- 2 Press **▼** to select 'PREFERENCES,' then press **OK**.
- 3 Select 'TV TYPE,' then press **▶**.
- 4 Use **▲▼** keys to select your preference and press **OK** to confirm.
- 5 To close the menu, press **SETUP** again.

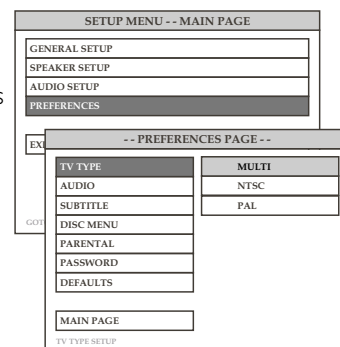

MULTI

- If the connected TV is compatible with both NTSC and PAL (multi-system,) select this mode. The output format will be in accordance with the video signal of the disc.

NTSC

- If the connected TV is NTSC system, select this mode. It will change the video signal of a PAL disc and output in NTSC format.

PAL

- If the connected TV is PAL system, select this mode. It will change the video signal of an NTSC disc and output in PAL format.

Selecting the type of video output

This setting is used to select the type of video connection between your DVD system and TV.

- 1 Press **SETUP**.
- 2 Select 'GENERAL SETUP,' then press **OK**.
- 3 Press **▼** to select 'VIDEO OUTPUT', then press **▶**.
- 4 Use **▲▼** keys to select your preference and press **OK** to confirm.
- 5 To close the menu, press **SETUP** again.

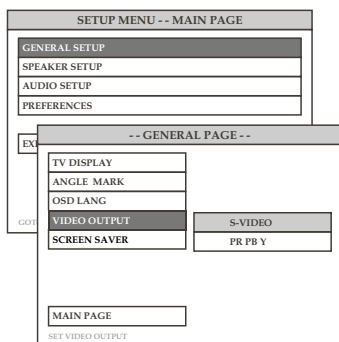

S-VIDEO (default setting)

– If you have connected the video output to your TV using S-Video jack.

PR PB Y

– If you have connected the video output to your TV using the Component Video Out (Pr/Cr Pb/Cb Y) jacks.

Selecting the On Screen Display (OSD) language

This setting is used for selecting the language of on-screen messages and menus.

- 1 Press **SETUP**.
- 2 Select 'GENERAL SETUP,' then press **OK**.
- 3 Press **▼** to select 'OSD LANG,' then press **▶**.
- 4 Use **▲▼** keys to select your preference and press **OK** to confirm.
→ The selected language will always be used for every disc to be played back. The default setting is 'ENGLISH.'
- 5 To close the menu, press **SETUP** again.
- 6 Press **DISPLAY** on the remote control to switch on/off the on screen display (OSD) on the TV.

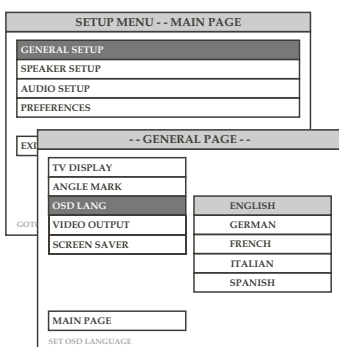

Helpful Hint:

– If the language selected is not available on the disc, the original language designated by each disc will be selected.

Changing the TV display

- 1 Press **SETUP**.
- 2 Select 'GENERAL SETUP,' then press **OK**.
- 3 Select 'TV DISPLAY,' then press **▶**.
- 4 Use **▲▼** keys to select your preference and press **OK** to confirm.
- 5 To close the menu, press **SETUP** again.

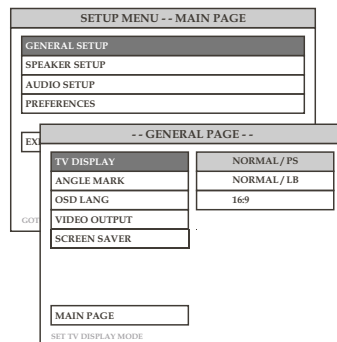

NORMAL / PS (default setting)

– If you have a conventional TV set and your DVD is not formatted for wide screen viewing, use this setting. A wide picture is displayed on the whole TV screen with a portion automatically cut off.

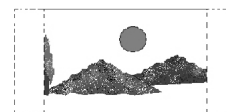

NORMAL / LB

– If you have a conventional TV set and your DVD is formatted for wide screen viewing, use this setting. Wide bands will be displayed on the upper and lower portions of the TV screen.



16:9

– If you have a wide screen TV set, use this setting (you must also set your wide screen TV to "full size".)

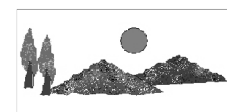

Helpful Hint:

– If your DVD is not encoded to allow you to change the aspect ratio, TV display cannot be changed.

Selecting the language for Audio/Subtitle/Disc Menu

You can select your preferred language settings so that this DVD system will automatically switch to the language for you whenever you load in a disc. If the language selected is not available on the disc, the disc's default setting language will be used instead.

- 1 Press **SETUP**.
- 2 Press **▼** to select 'PREFERENCES,' then press **OK**.
- 3 Press **▼** to select 'AUDIO', 'SUBTITLE' or 'DISC MENU', then press **▶**.
→ If the language selected is not available on the disc, the original language designated by each disc will be selected.
- 4 Use **▲▼** keys to select your preference and press **OK** to confirm.
- 5 To close the menu, press **SETUP** again.

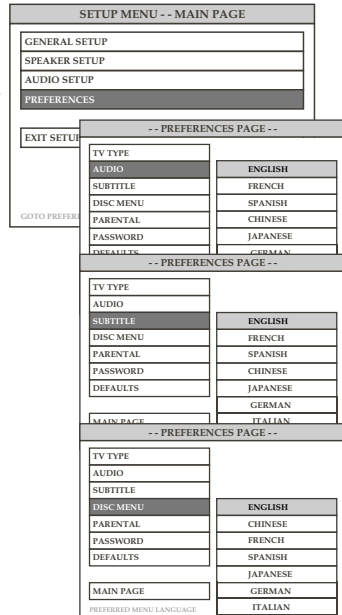

Helpful Hint:

- You must stop playback before selecting this function.

Changing and testing the speakers setting

- 1 Press **SETUP**.
- 2 Press **▼** to select 'SPEAKER SETUP,' then press **OK**.
- 3 Select 'CNTR DELAY', 'REAR DELAY' or 'TEST,' then press **▶**.
- 4 Use **▲▼** keys to select your preference and press **OK** to confirm.
- 5 To close the menu, press **SETUP** again.

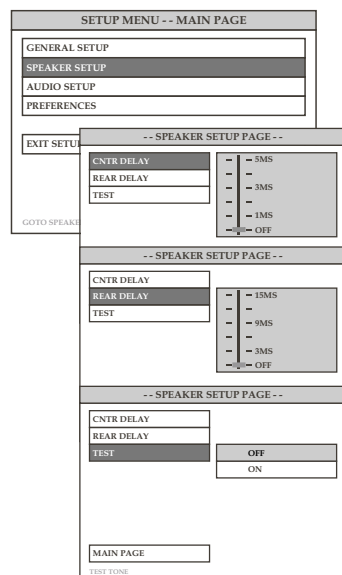

Center Delay (CNTR DELAY)

- If the listening position is closer to the center speaker than the front speakers, you can set the center delay time to improve the surround sound effect.

Rear Delay

- If the listening position is closer to the rear surround speakers than the front speakers, you can set the rear delay time to improve the surround sound effect.

Test Tone (TEST)

- If set to 'ON,' the system will test the speaker settings. The test signal is generated through the left, center, right, and surround speakers.

Setting the digital output

Digital output selection enables you to specify the type of digital output suitable for your DVD system.

- 1 Press **SETUP**.
- 2 Press **▼** to select 'AUDIO SETUP,' then press **OK**.
- 3 Select 'DIGITAL OUT,' then press **▶**.
- 4 Use **▲▼** keys to select your preference and press **OK** to confirm.
- 5 To close the menu, press **SETUP** again.

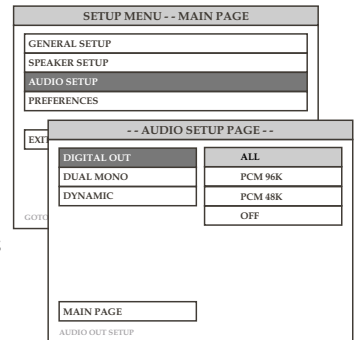

ALL

- If you have connected the digital output to a multichannel decoder receiver.

PCM 96K

- If the external component is capable of processing digital signal input with sampling rates of 96 kHz.

PCM 48K

- If the external component is incapable of processing 96 kHz digital signals input, then convert to standard signal with sampling rates of 48 kHz.

OFF (default setting)

- To deactivate the digital output.

Changing the sound channel (for discs with Dolby

Digital mode only)

- 1 Press **SETUP**.
- 2 Press ▼ to select 'AUDIO SETUP,' then press **OK**.
- 3 Press ▼ to select 'DUAL MONO,' then press ►.
- 4 Use ▲▼ keys to select your preference and press **OK** to confirm.
- 5 To close the menu, press **SETUP** again.

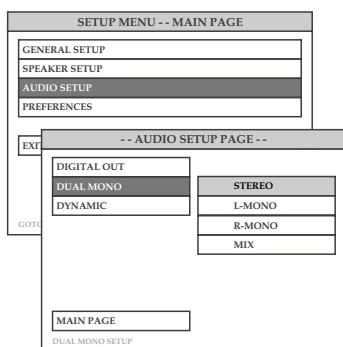

STEREO (default setting)

– It reproduces both channels as stereo.

L MONO

– It reproduces left mono signal to front left and right channels.

R MONO

– It reproduces right mono signal to front left and right channels.

MIX

– It reproduces both channels mix together.

The same function can also be accessed from the AUDIO button on the remote control.

Balancing the volume level through setting the dynamic range (for discs with Dolby

Digital mode only)

- 1 Press **SETUP**.
- 2 Press ▼ to select 'AUDIO SETUP,' then press **OK**.
- 3 Press ▼ to select 'DYNAMIC,' then press ►.
- 4 Use ▲▼ keys to select your preference and press **OK** to confirm.
- 5 To close the menu, press **SETUP** again.

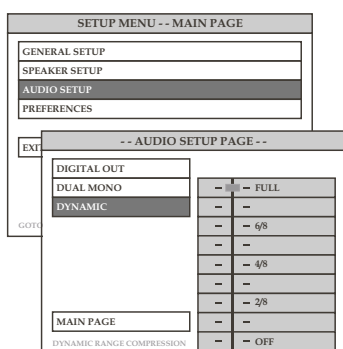

FULL (full compressed dynamic range)

– High volume outputs are softened and low volume outputs are brought upwards to audible level.

7/8 ~ 1/8 (partially compressed dynamic range)

OFF (uncompressed dynamic range)

Activating the camera angle indication

- 1 Press **SETUP**.
- 2 Select 'GENERAL SETUP,' then press **OK**.
- 3 Press ▼ to select 'ANGLE MARK,' then press ►.
- 4 Use ▲▼ keys to select your preference and press **OK** to confirm.
→ If set to 'ON,'  will be displayed on the screen when a picture is recorded in multiple angle.
- 5 To close the menu, press **SETUP** again.

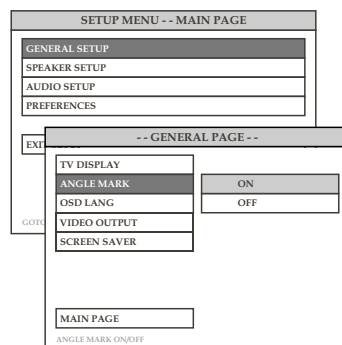

Activating screen saver

- 1 Press **SETUP**.
- 2 Select 'GENERAL SETUP,' then press **OK**.
- 3 Press ▼ repeatedly to select 'SCREEN SAVER,' then press ►.
- 4 Use ▲▼ keys to select your preference and press **OK** to confirm.
- 5 To close the menu, press **SETUP** again.
→ If set to 'ON,' when you leave the system in stop or pause mode for more than one minute, the screen saver will appear on the TV screen.

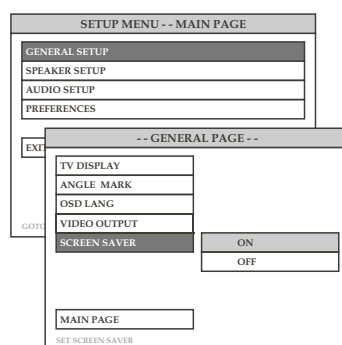

Restoring the original settings

- 1 Press **SETUP**.
- 2 Press ▼ to select 'PREFERENCES,' then press **OK**.
- 3 Press ▼ to select 'DEFAULTS,' then press ►.
→ All the items in the setup menu will be restored to the original factory setting.
- 4 To close the menu, press **SETUP** again.

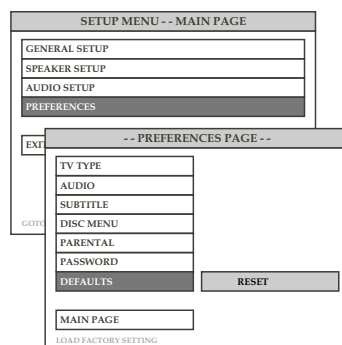

Helpful Hint:

– The parental control and its unlocking password will not be reset.

Setting the parental control level

This feature lets you set a playback limitation level. Some DVDs may have a parental level assigned to the complete disc or to certain scenes on the disc. The rating levels are from 1 to 8 and are country dependent. You can prohibit the playing of certain discs that are not suitable for your children or have certain discs played with alternative scenes.

- 1 Press **SETUP**.
- 2 Press **▼** to select 'PREFERENCES,' then press **OK**.
- 3 Press **▼** to select 'PARENTAL,' then press **▶**.
- 4 Use **▲▼** keys to select your preference and press **OK** to confirm.
- 5 To close the menu, press **SETUP** again.

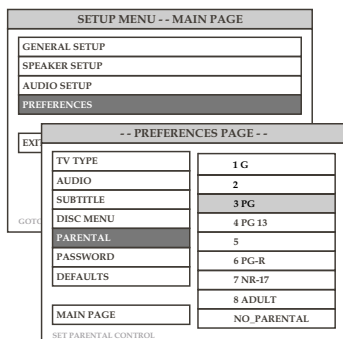

Rating - NO PARENT

If parental control is not activated, it will play all discs.

Rating - 1 to 8

If the player's parental level is set below 8, only discs with a lower or equal level will play. For example, if the player is set to 6, only discs with ratings of 6, 4, 3 and 1 will be played. Higher rated scenes will not be played unless an alternative that has the same rating or lower is available on the disc. For example, consider a disc that generally is suitable for most audiences, and it is rated at level 1 for the most part. However, in the middle, there are also scenes rated at 6 (not suitable for children).

Rating explanations

- 8 ADULT** – Mature material; should be viewed only by adults due to graphic sexual material, violence, or language.
- 7 NC-17** – No children under age 17; not recommended viewing for children under age 17.
- 6 PG-R** – Parental Guidance - Restricted; recommended that parents restrict children under 17 from viewing or allow to view only when supervised by a parent or adult guardian.
- 5** – Reserved.
- 4 PG13** – Material is unsuitable for children under age 13.
- 3 PG** – Parental Guidance suggested.
- 2** – Reserved.
- 1 G** – General Audience; recommended as acceptable for viewers of all ages.

Helpful Hint:

– Some DVDs are not encoded with a rating though the movie rating is printed on the disc jacket. The rating level feature does not work for such discs.

Changing the parental control password

The original preset password is '1234'.

- 1 Press **SETUP**.
- 2 Press **▼** to select 'PREFERENCES,' then press **OK**.
- 3 Press **▼** to select 'PASSWORD,' then press **▶**.
- 4 Select 'CHANGE,' then press **OK**.
- 5 Use the **numeric keypad (0-9)** to enter your **old** 4-digit password in the box beside the 'OLD PASSWORD.'
(If this is the first time you have set a password, press **1234**.)
→ 'XXXX' will appear as you enter the numbers.
- 6 Enter a **new** 4-digit password of your choice in the box beside 'NEW PASSWORD.'
- 7 Enter the **new** 4-digit password once again in the box beside 'CONFIRM PASSWORD,' then press **OK**.
- 8 To close the menu, press **SETUP** again

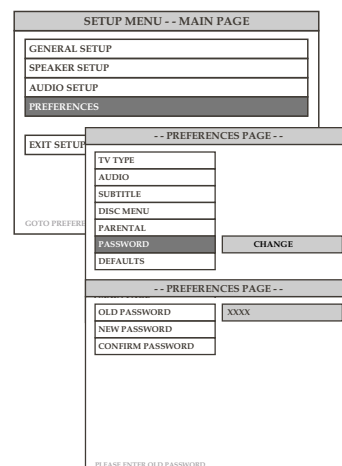

IMPORTANT!

- DVD discs and players are designed with regional restrictions. Before playing a disc, make sure the disc is for the same zone as your player.
- Depending on the DVD or VIDEO CD, some operations may be different or restricted.
- Do not push on the disc tray or put any objects other than discs on the disc tray. Doing so may cause the disc player to malfunction.
- Do not move the disc player during playback, as doing so may damage the DVD system.

Playable discs

Your DVD player is able to play :

- Digital Video Discs (DVDs)
- Video CDs (VCDs)
- SuperVideo CDs (SVCDs)
- Digital Video Discs + Rewritable (DVD+RW)
- Compact Discs (CDs)
- MP3 discs, Picture (Kodak, JPEG) files on CD-R(W).

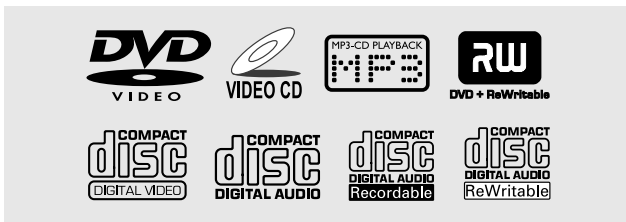

Region Codes

DVDs must be labeled for **ALL** regions or for **Region 1** in order to play on this DVD system. You cannot play discs that are labeled for other regions.



Helpful Hint:

- If you are having trouble playing a certain disc, remove the disc and try a different one. Improperly formatted discs will not play on this DVD system.

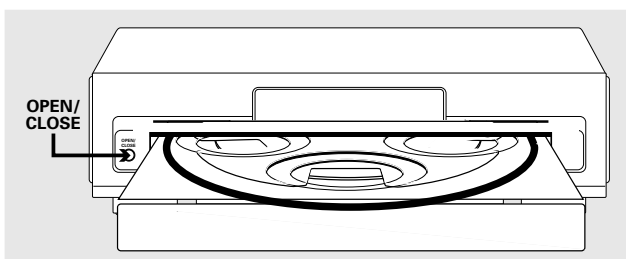

Disc playback

- 1 Press **POWER ON•OFF** ϕ , then press **DVD**.
- 2 Turn on the TV power and set to the correct Video In channel or Audio/Video mode.
→ The DVD system's default screen will show on the TV.
- 3 Press **OPEN•CLOSE** \blacktriangle to open the disc tray.
- 4 Load a disc with the label side facing up.



- 5 If you want load in more discs, press **DISC SKIP** to rotate the disc carousel tray. Maximum up to 5 discs could be loaded in the disc carousel tray.
- 6 Press **OPEN•CLOSE** \blacktriangle again to close the tray.
→ There will be a short delay while the player identifies all the available discs and reads the menu from the disc.
- 7 Playback may start automatically, if not, press **▶||**.
- Some discs will start playing automatically, and others will display the Disc Contents Menu on the TV screen. If the menu is presented, use \blacktriangle \blacktriangle \blacktriangledown keys to highlight your selection and press **OK** to confirm. To select a play option, press **numeric keypad (0-9, >10)**.

Helpful Hints:

- Your player will not play discs that have a region code different from the region code of your player.
-  If the inhibit icon appears on the TV screen when a  button is pressed, it means the function is not available on the disc you are playing.

Basic playback controls

- ▶||**
 - Starts playback or pause.
 - Resumes playback of a stopped disc (DVD only).
- - Stops playback.
- ⏮ (⏮)**
 - Skips to the previous track/chapter.
- ⏭ (⏭)**
 - Skips to the next track/chapter.
- ⏪**
 - Starts Fast reverse scanning. Press **▶||** to resume normal playback.
- ⏩**
 - Starts Fast forward scanning. Press **▶||** to resume normal playback.

numeric keypad (0-9, >10)

- Selects the title, chapter or track number of the disc to start playback.
- For double digit number, press **>10** and followed by the next number. For example, to select 25, press **>10** **twice** ("2-" will appear), then press 5.

DISC 1~5

- Starts playback the selected disc.

DISC NO

- While playing a disc, display the disc number.

DISC SKIP

- Selects the next available disc.

Helpful Hint:

- If the **REPEAT** or **SHUFFLE** mode is active, pressing \blacktriangle \blacktriangle or \blacktriangleright \blacktriangleright will cause the disc to skip to the previous or next track/chapter/title within the limits of the **REPEAT** or **SHUFFLE**.

Resuming playback from the last stopped point (DVD only)

- In stop mode and when a disc has not been ejected, press ► **II**.

To cancel the resume mode

- In stop mode, press ■ again.

Helpful Hints:

- When the player is disconnected from the power supply or the disc tray is opened, the resume option will be cancelled automatically.
- The resume option may not be available on some discs.

Repeat play mode

You can only select the repeat play mode during playback.

- While playing a disc, press **REPEAT** repeatedly to select different repeat mode.
 - If repeating chapter/current track, "REPEAT 1" appears on the display.
 - If repeating title/current disc/programmed tracks, "REPEAT" appears on the display.
 - If repeating all available CDs, "REPEAT" flashes on the display.

For DVD

- repeat chapter
- repeat title

For VCD/CD/MP3

- Repeat the current track
- Repeat the current disc

For CD (in CD mode only)

- Repeat the current track
- Repeat the current disc
- Repeat all the available CDs
- Repeat programmed tracks (only in CD program mode)

To cancel the repeat mode

- Press **REPEAT** repeatedly to select "REPEAT OFF."

Helpful Hints:

- On a VCD, repeat play is not possible during PBC playback.
- The disc tray must contain more than two discs in order to activate repeat all discs feature in CD mode.

Repeat playback a specific section/passage continuously

You can set to play a specific section in a title, chapter or track repeatedly.

- 1 While playing a disc, press **A-B** at your chosen starting point.
- 2 Press **A-B** again at your chosen end point.
 - The passage will now repeat continuously.
- 3 To resume normal play, press **A-B** again.

Helpful Hints:

- On a DVD, you are able to mark the A-B across a chapter.
- On a VCD, make sure the entire A-B section is within a single track.

Fast searching for a particular passage

- 1 Press ◀◀ or ▶▶ on the remote control to fast reverse or forward the disc. There are four scan speeds. Each press will increase the speed : (FF) - fast forward and (FR) - fast reverse.

For DVD/MP3

FF 2x → FF 4x → FF 6x → FF 8x → PLAY
FR 2x → FR 4x → FR 6x → FR 8x → PLAY

For VCD/CD

FF 1x → FF 2x → FF 3x → FF 4x → PLAY
FR 1x → FR 2x → FR 3x → FR 4x → PLAY

For VCD/CD, when the search reaches the end of the track, it will resume normal playback at the beginning of next track.

- 2 To resume normal play, press ► **II**

Special DVD/VCD features

Using the DVD title menu

Some DVDs may contain two or more titles. If the disc has a title menu recorded on it, you can start playback from the selected movie title.

- 1 Press **TITLE**.
 - A list of the DVD's titles appears.
- 2 Use ◀▶▲▼ or the **numeric keypad (0-9, >10)** to select the desired title, followed by ► **II** or **OK**.
 - The selected title starts playing.

Helpful Hints:

- The details of operation might differ depending on the DVD.
- Selecting a title might not be possible on certain DVDs.

Using the DVD root menu

Some DVDs have unique DVD menus. For example, DVDs programmed with complex contents provide guide menus, and those recorded with various languages provide menus for audio and subtitle language. The DVD menu's contents and operation differ from disc to disc.

- 1 Press **MENU** on the remote control during playback.
 - The DVD menu available on the disc appears.
 - If the DVD is recorded without a disc menu, pressing MENU will either restart playback, go back to the title menu, or have no effect.
- 2 Use ◀▶▲▼ or the **numeric keypad (0-9, >10)** to select the desired title, followed by ► **II** or **OK**.
 - The selected scene starts playing.

Changing the audio/subtitle language for the current disc only

- Press **LANGUAGE** to change the audio language and **SUBTITLE** to change the subtitle language from the selection available on the disc.
 - The changes are only applied to the current disc, it will not change the default preset (see "Selecting the language for Audio/Subtitle/Disc Menu".)

Viewing from another angle

If the disc contains sequences recorded from different camera angles, this allows you to view the picture from different angles. The selections of angle are depending on the disc format.

- While playing a disc, press **ANGLE** repeatedly to select the desired angle.
 - Playback changes to the selected angle.

Searching for a particular title, chapter or time elapsed

While playing a DVD

- 1 Press **GOTO**.
- 2 Press **◀▶** to select 'TITLE' or 'CHAPTER' search or press **GOTO** again to enter time search.
- 3 Use **numeric keypad (0-9, >10)** to input the specific title, chapter or elapsed playing time at which you want to begin playback.
- 4 Press **OK**.

While playing a VCD (the PBC mode must set to off)

- 1 Press **GOTO**.
- 2 Use **numeric keypad (0-9, >10)** to input the specific elapsed playing time at which you want to begin playback.

Zooming in

This function allows you to enlarge the picture on the TV screen and to pan through the enlarged image.

- 1 While playing a disc, press **ZOOM** repeatedly to select a zoom factor : **1 → 2 → OFF**.
- 2 To shift the enlarged image on the TV screen, use **◀▶▲▼** keys to move the zoomed picture left, right, up and down.
- 3 To return the picture to regular size, press **ZOOM** repeatedly to select 'OFF'.

Helpful Hint:

– Zooming may not be possible on certain DVDs/VCDs.

Playing in slow motion mode

- 1 While playing a disc, press **SLOW/MEM** repeatedly to select the required slow motion speed : (**SF**) - slow forward and (**SR**) - slow reverse.

For DVD

SF 2x → SF 4x → SF 8x → SR 2x → SR 4x → SR 8x → PLAY

For VCD

SF 1x → SF 2x → SF 3x → PLAY

- 2 To resume normal play, press **▶II**.

Helpful Hints:

- The sound will be muted during slow-motion play.
- The slow-motion playback function is not possible on CD and MP3-CD.

Using the Playback Control (PBC) feature (VCD only)

PBC playback allows you to play Video CDs interactively, following the menu on the display.

To set PBC on/off

- Stop playback and press **MENU** on the remote control to toggle between 'PBC ON' and 'PBC OFF'.

When playing a disc with PBC, If PBC is set to Off

- Once the disc is loaded in the disc tray, it will start playback automatically.

If PBC is set to On

- Once the disc is loaded in the disc tray, the PBC menu (if available) will appear on the TV screen for selection. Use the **numeric keypad (0-9, >10)** to enter your choice.
- Pressing **TITLE** during playback will return to the PBC menu.

Helpful Hint:

– If PBC mode is switched on, none of the REPEAT functions are available.

Special CD features

Playing CDs only

When activating CD MODE, only CDs will be played. The system will automatically skip over any DVDs or Video CDs in the disc carousel tray. This may be useful if you have a mixture of discs loaded but only want to play music CD.

- 1 Stop playback and press **CD MODE**.
 - A red symbol "▶" appears on the FTD indicating that the set is in CD mode.
- 2 Press **▶II**.
 - All the available audio CDs will play once, then stop.
- During playback, you can press **DISC SKIP** to select the next available audio CD.
 - The selected disc will play once, then stop.
- 3 To stop playback, press **■**.
- 4 To exit, press **CD MODE** when in stop mode.

Shuffle play mode

You can playback CD tracks in random order.

To shuffle play one CD:

- 1 Stop playback.
- 2 Press **SHUFFLE** to turn on shuffle function.
→ "SHUFFLE ON" is briefly displayed.
- 3 Press **▶II** to start shuffle play.
- 4 To cancel shuffle play, press **■** twice.

To shuffle play all CDs:

- Stop playback and press **CD MODE**, then follow the above **steps 2-4**.

Program favorite tracks

You can play the contents of the disc in the order you want by programming the order of the tracks to be played. Up to 99 tracks can be stored. This function is only available when CD MODE is selected.

- 1 Stop playback and press **CD MODE**.
- 2 Press **PROGRAM** to enter program mode.
→ "P 00:00" and "PROG" is displayed.
- 3 Press **DISC SKIP** (or **DISC 1~5** on the system) to select a disc number.
→ The respective disc button will flash (DISC X).
- 4 Use the **numeric keypad (0-9, >10)** to input the track number in the order you want.
→ "P XX:YY" is displayed. "XX" is the program number and "YY" is the selected track number.
- Repeat **steps 3-4** to store other tracks.
- 5 To start program play, press **▶II**.
- 6 During program playback, press **◀▶** (or **◀◀/▶▶** on the system) to select the next or previous programmed track.
- 7 To stop playback, press **■** once.
- 8 To cancel the program, press **■** again.

Helpful Hints:

- If you attempt to program more than 99 tracks, "FULL" is displayed.
- The programmed contents are lost if you turn off the DVD system or open the disc tray.

Playing MP3/Picture disc (Kodak, JPEG)

Supported MP3 format

- JPEG format
- Max. 12 characters
- Max. nested directory is 7 levels
- The max. album number is 32
- Supported VBR bit-rate
- Supported sampling frequencies for MP3 disc are :
32 kHz, 44.1 kHz, 48 kHz
- Supported Bit-rates of MP3 disc are: 32, 64, 96, 128, 192, 256 (kbps)

IMPORTANT!

You have to turn on your TV and set to the correct Video In channel (see page 13 – Switching on the system).

MP3 / JPEG Picture disc

- 1 Load an MP3/Picture (JPEG) disc.
→ The disc reading time may exceed 30 seconds due to the complexity of the directory/file configuration.
- 2 Playback will start automatically. If not, press **▶II** to start playback.
- 3 Press **◀▶** (or **◀◀/▶▶** on the system) to select the previous or next track.
- 4 To turn the album/picture menu ON, press **MENU** on the remote control when in stop mode.
→ The album/picture menu will appear on the TV screen.
- 5 Press **▲▼◀▶** to select a desired album, then press **OK** or **▶II** to confirm (for MP3 disc only).
→ The title menu appears on the TV screen.
- 6 Press **▲▼◀▶** to select a desired title, then press **OK** or **▶II** to start playback.
- You can also use the **numeric keypad (0-9, >10)** to enter your choice.
- 7 To stop playback, press **■**.

Kodak Picture disc

- 1 Load a Kodak Picture disc.
→ The disc reading time may exceed 30 seconds due to the complexity of the directory/file configuration.
- 2 Playback will start automatically.
- 3 Press **■**.
→ 9 thumbnail pictures will appear on the TV.
- 4 Press **◀▶** (or **◀◀/▶▶** on the system) to view the previous/next page (if available).
- 5 Press **▲▼◀▶** to navigate through the 9 thumbnail pictures, and press **OK** to select the desired picture to play.
- 6 To stop playback, press **■** twice.

During playback, you can;

- Press **◀▶** (or **◀◀/▶▶** on the system) to select another title/picture in the current folder.
- Use **◀▶▲▼** keys on the remote to rotate or flip the picture files.
- Press **▶II** to pause/resume playback.

Helpful Hints:

- Stop playback before remove the disc.
- Due to the recording nature of Digital Audio MP3 (DAM), only digital audio music will play.
- It is normal to experience an occasional "skip" while listening to your MP3 discs.
- Some files on Kodak or JPEG discs may be distorted during playback due to the configuration and characteristics of the disc.
- For multi-session discs with different formats, only the first session will be available.
- MENU key function is not available during Kodak picture disc playback.

Tuning to radio stations

- 1 Press **POWER ON•OFF** to switch on the last selected source.
- 2 Press **TUNER•BAND** (or press **SOURCE** on the remote control repeatedly) to select TUNER mode.
- 3 Press **TUNER•BAND** again to select the desired band : FM or AM.
- 4 Press and hold **◀◀** or **▶▶** (or **◀** / **▶** on the remote control) until the frequency indication starts to change, then release.
→ The system automatically tunes to the next strong radio station.

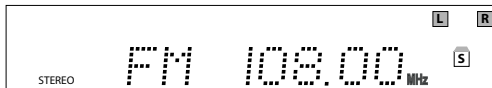

- To tune to a weak station, press **◀◀** or **▶▶** (or **◀** / **▶** on the remote control) briefly and repeatedly until an optimal reception is found.
 - To reduce the noise and make the radio reception clearer, press **ST/MONO** to switch to monaural mode.
- 5 Repeat **step 4** if necessary until you find the desired radio station.

Presetting radio stations

You can preset up to 40 stations regardless of the reception.

- 1 Tune to your desired radio station (refer to "Tuning to radio stations".)
- 2 Press **SLOW/MEM**.
→ "PROG" icon starts flashing.

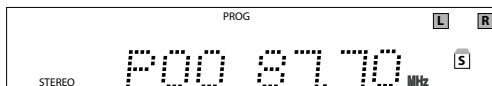

- 3 Use the **numeric keypad (0-9, >10)** to select the desired preset number.
→ If "PROG" icon goes off before you select the desired preset number, press SLOW/MEM again.

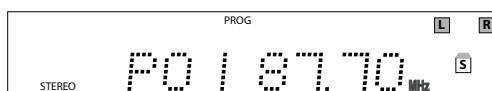

- 4 Press **SLOW/MEM** again or wait for a few seconds to store the radio station.
- Repeat **steps 1–4** to store other radio stations.

Helpful Hint:

– During programming, if no button is pressed within five seconds, the system will exit the program mode automatically.

Listening to preset radio stations

- In tuner mode, press **◀◀** / **▶▶** or use the **numeric keypad (0-9, >10)** to select the desired preset number.
→ The preset number, radio frequency, and waveband are displayed.

Volume control

Adjust **VOLUME** button (or press **VOL + / -**) to increase or decrease the volume level.

To listen through the headphones

- Connect the headphones plug to the **PHONES**  socket at the front of the DVD system.
→ The speakers will be muted.

To switch off the volume temporarily

- Press **MUTE**.
→ "MUTE" icon appears.
- To restore the volume, press **MUTE** again.

Adjusting the speakers' tones and channels (for discs with Dolby Digital mode only)

You can change the speakers' sound distribution to suit your surround sound needs and adjust the treble/bass level to define the sound-processor settings. For example, if you are closer to the left front speaker than the right front speaker, the left front speaker might seem "louder" than the right one. To adjust it, you must change the channel level for one or both speakers until the sound evens out.

- 1 While playing a disc, press **SELECT** repeatedly to select :
TREBLE LEVEL → BASS LEVEL → FRONT LEFT
→ CNT → FRONT RIGHT → SURROUND RIGHT
→ SURROUND LEFT → SUBWOOFER
→ TREBLE LEVEL ...
- 2 While the level indicator appears on the display, immediately press **VOL + / -** to select the desired treble, bass or speaker's level (-15~ +10.)

Helpful Hints:

- If the volume button is not used within five seconds, it will resume its normal volume control function.
- If no button is pressed within a few seconds, the system will exit automatically.

Dimming the display screen

You can change the brightness of the display panel on the front of the DVD system.

- Press **DIM** to toggle between DIM 1, DIM 2 and DIM OFF mode.

Selecting Listening mode

This DVD system has a built in Dolby Digital decoder.

When listening to a DVD with Dolby Digital signal

- Press **LISTENING** repeatedly to select :
Dolby Digital → Stereo

When listening to a DVD with PCM or 2-channel signal

- Press **LISTENING** repeatedly to select :
Dolby Pro Logic → Stereo

When listening to a VCD, MP3-CD or audio CD

- Press **LISTENING** repeatedly to select :
Dolby Pro Logic → Stereo

Sleep timer setting

The sleep timer enables the system to switch to standby mode automatically at a preset time.

- 1 Press **SLEEP** repeatedly to select a preset time.
→ The selections are as follows (time in minutes):
120 → 110 → 100... → 20 → 10 → OFF
- 2 When you reach the desired length of time, stop pressing the **SLEEP** button.
→ "SLEEP" icon appears.

To check the remaining length of time after sleep timer is activated

- Press **SLEEP** once.

To change the preset sleep timer

- Press **SLEEP** again while the remaining sleep timer is shown.
→ The display will show the next sleep timer options.

To deactivate the sleep timer

- Press **SLEEP** repeatedly until it reaches "OFF."

AMPLIFIER SECTION

Output power	300 W
- Stereo mode (DIN)	2 x 50 W RMS
.....	2 x 40 W FTC
Total Harmonic Distortion	10% at rated power (1 kHz)
Frequency Response	180 Hz – 14 kHz / ±1 dB
Signal-to-Noise Ratio	> 65 dB (CCIR)
Input Sensitivity	400 mV

TUNER SECTION

Tuning Range	FM 87.5 – 108 MHz (100 kHz steps)
.....	AM 530 – 1710 kHz (10 kHz steps)
26 dB Quieting Sensitivity	FM 20 dB
26 dB Quieting Sensitivity	AM 3162 μ V/m
Image Rejection Radio	FM 25 dB
.....	AM 28 dB
IF Rejection Ratio	FM 60 dB
.....	AM 24 dB
Signal-to-Noise Ratio	FM 60 dB
.....	AM 40 dB
AM Suppression Ratio	FM 30 dB
Harmonic Distortion	FM Mono 3%
.....	FM Stereo 3%
.....	AM 5%
Frequency Response	FM 180 Hz – 10 kHz / ±6 dB
Stereo Separation	FM 26 dB (1 kHz)
Stereo Threshold	FM 23.5 dB

DVD SECTION

Laser Type	Semiconductor
Disc Diameter	12cm / 8cm
Video Decoding	MPEG-2
Video DAC	10 Bits
Signal System	PAL / NTSC
Video Format	4:3 / 16:9
Video S/N	56 dB (minimum)
Composite Video Output	1.0 Vp-p, 75 Ω
S-Video Output	Y - 1.0 Vp-p, 75 Ω
.....	C - 0.286 Vp-p, 75 Ω
Audio DAC	24 Bits / 96 kHz
Frequency Response	4 Hz – 20 kHz (44.1 kHz)
.....	4 Hz – 22 kHz (48 kHz)
.....	4 Hz – 44 kHz (96 kHz)
Digital Output	SPDIF Coaxial & Optical

MISCELLANEOUS

Power Supply Rating	120 V / 60 Hz
Power Consumption	160 W
Dimensions (w x h x d)	430 mm x 140 mm x 420 mm
.....	17.0 x 5.5 x 16.5 (inch)
Weight	10 kg
.....	22 pounds

IR REMOTE CONTROL

Effective Range	> 8 Meters
Battery (1.5V)	AAA x 2

SPEAKERS

Front speakers / Rear (surround) speaker

System	2-way satellite
Impedance	8 Ω
Speaker drivers	3" woofer, piezo
Dimensions (w x h x d)	94 mm x 155 mm x 88 mm
.....	3.7 x 5.9 x 3.5 (inch)
Weight	0.5 kg / 1.1 pounds each

Center speaker

System	2-way satellite
Impedance	8 Ω
Speaker drivers	2 x 3" woofer, piezo
Dimensions (w x h x d)	250 mm x 95 mm x 90 mm
.....	9.8 x 3.7 x 3.5 (inch)
Weight	0.87 kg / 1.91 pounds

PASSIVE SUBWOOFER

System	6.5"
Impedance	8 Ω
Dimensions (w x h x d)	200 mm x 319 mm x 345 mm
.....	7.87 x 12.56 x 13.58 (inch)
Weight	5.2 kg / 11.44 pounds

Specifications subject to change without prior notice

Troubleshooting

WARNING!

Under no circumstances should you try to repair the system yourself, as this will invalidate the warranty. Do not open the system as there is a risk of electric shock.

If a fault occurs, first check the points listed below before taking the system for repair. If you are unable to solve a problem by following these hints, consult your dealer or call **1800-705-2000**.

Problem	Solution
No power.	<ul style="list-style-type: none">– Check if the AC power cord is properly connected.
No picture.	<ul style="list-style-type: none">– Check if the TV is switched on.– Check the video connection.– Press DVD button on the system.– Set your TV to the correct Video In channel. These channels are usually near channel 00. Or, you may have a button on the TV remote control that selects Auxiliary or A/V IN channel. See your TV owner's manual for details. Or, change channels at the TV until you see DVD screen on the TV.
Distorted or poor picture.	<ul style="list-style-type: none">– Sometimes a small amount of picture distortion may appear. This is not a malfunction.– Clean the disc.– Check the video connection. You cannot use S-Video and Component Video connections at the same time.
Completely distorted picture or black/white picture.	<ul style="list-style-type: none">– Make sure the NTSC/PAL setting at the DVD system matches the video signal of your television (see "System Setup (DVD) - Selecting the color system that matches the connected TV").
The aspect ratio of the screen cannot be changed even though you have set the TV display.	<ul style="list-style-type: none">– The aspect ratio is fixed on the DVD disc.– Depending on the TV, it may not be possible to change the aspect ratio.
No sound or distorted sound.	<ul style="list-style-type: none">– Adjust the volume.– Check that the speakers are connected correctly.– Replace the speaker cables.– Check the speaker settings.– The system is in pause, slow motion or fast forward/reverse mode, press PLAY to resume normal play mode.
The DVD player does not start playback.	<ul style="list-style-type: none">– Insert a readable disc with the playback side facing down.– Check the disc type, color system and regional code. Check for any scratches or smudges on the disc.– Press SETUP to turn off the setup menu screen.– Cancel the parental control rating function or change the rating level.– Moisture has condensed inside the system. Remove the disc and leave the system turned on for about an hour.
The DVD system does not respond when the buttons are pressed.	<ul style="list-style-type: none">– Disconnect the power plug from the outlet and insert again.
Cannot activate some features, such as Angles, Subtitles, or multi-language Audio.	<ul style="list-style-type: none">– Multi-language sound or subtitle is not recorded on the DVD.– Changing the language for the sound or subtitle is prohibited on the DVD.– The features may not be available on the disc.
No image is output when a function is selected.	<ul style="list-style-type: none">– Make sure the component is connected correctly.– Press the correct function button for the input source.
Considerable noise in radio broadcasts.	<ul style="list-style-type: none">– Tune in to the correct frequency.– Connect the antenna.– Route RF (AC-3) and digital cables away from the antenna terminals and wires.– Fully extend the FM wire antenna. Position for best reception and secure to a wall.– Connect an outdoor FM or AM antenna.– Adjust the direction and position for best reception.– Turn off the equipment causing the noise or move it away from the DVD system.– Place the antenna farther away from any equipment that may be causing the noise.
The remote control does not function.	<ul style="list-style-type: none">– Point the remote control at the remote sensor of the unit.– Reduce the distance to the player.– Remove any possible obstacles.– Replace the batteries with new ones.– Check that the batteries are loaded correctly.
The display is dark.	<ul style="list-style-type: none">– Press DIM again.
Low hum or buzz sound.	<ul style="list-style-type: none">– Place the DVD system as far away as possible from electrical devices that may be causing interference.
Low bass response.	<ul style="list-style-type: none">– Check all speakers for correct polarity.

Analog: Sound that has not been turned into numbers. Analog sound varies, while digital sound has specific numerical values. These jacks send audio through two channels, the left and right.

Aspect ratio: The ratio of vertical and horizontal sizes of a displayed image. The horizontal vs. vertical ratio of conventional TVs is 4:3, and that of wide-screens is 16:9.

AUDIO OUT Jacks: Jacks on the back of the DVD System that send audio to another system (TV, Stereo, etc.).

Bit Rate: The amount of data used to hold a given length of music; measured in kilobits per seconds, or kbps. Or, the speed at which you record. Generally, the higher the bit rate, or the higher the recording speed, the better the sound quality. However, higher bit rates use more space on a Disc.

Chapter: Sections of a picture or a music piece on a DVD that are smaller than titles. A title is composed of several chapters. Each chapter is assigned a chapter number enabling you to locate the chapter you want.

Component Video Out Jacks: Jacks on the back of the DVD System that send high-quality video to a TV that has Component Video In jacks (R/G/B, Y/Pb/Pr; etc.).

Disc menu: A screen display prepared for allowing selection of images, sounds, subtitles, multi-angles, etc recorded on a DVD.

Digital: Sound that has been converted into numerical values. Digital sound is available when you use the DIGITAL AUDIO OUT COAXIAL or OPTICAL jacks. These jacks send audio through multiple channels, instead of just two channels as analog does.

Dolby Digital: A surround sound system developed by Dolby Laboratories capable of delivering up to 5.1 discrete channels of audio (front left and right, surround left and right, center, and LFE.)

JPEG: A still-picture data compression system proposed by the Joint Photographic Expert Group, which features small decrease in image quality in spite of its high compression ratio.

MP3: A file format with a sound data compression system. "MP3" is the abbreviation of Motion Picture Experts Group 1 (or MPEG-1) Audio Layer 3. By using MP3 format, one CD-R or CD-RW can contain about 10 times as much data volume as a regular CD can.

Multichannel: DVD is specified to have each sound track constitute one sound field. Multichannel refers to a structure of sound tracks having three or more channels.

Parental control: A function of the DVD to limit playback of the disc by the age of the users according to the limitation level in each country. The limitation varies from disc to disc; when it is activated, playback will be prohibited if the software's level is higher than the user-set level.

PCM (Pulse Code Modulation): A system for converting analog sound signal to digital signal for later processing, with no data compression used in conversion.

Playback control (PBC): Refers to the signal recorded on video CDs or SVCDs for controlling reproduction. By using menu screens recorded on a Video CD or SVCD that supports PBC, you can enjoy interactive-type software as well as software having a search function.

Progressive Scan: It displays all the horizontal lines of a picture at one time, as a signal frame. This system can convert the interlaced video from DVD into progressive format for connection to a progressive display. It dramatically increases the vertical resolution. A progressive-scan TV is needed to receive progressive scan output from the player.

Region code: A system for allowing discs to be played back only in the region designated beforehand. This unit will only play discs that have compatible region codes. You can find the region code of your unit by looking on the product label. Some discs are compatible with more than one region (or ALL regions).

S-Video: Produces a clear picture by sending separate signals for the luminance and the color. You can use S-Video only if your TV has S-video In jack.

Sampling Frequency: Frequency of sampling data when analog data is converted to digital data. Sampling frequency numerically represents how many times the original analog signal is sampled per second.

Surround: A system for creating realistic three-dimensional sound fields full of realism by arranging multiple speakers around the listener.

Title: The longest section of a picture or music feature on DVD, music, etc., in video software, or the entire album in audio software. Each title is assigned a title number enabling you to locate the title you want.

VIDEO OUT jack: Jack on the back of the DVD System that sends video to a TV.

LIMITED WARRANTY

MAGNAVOX AUDIO SYSTEM

One Year Free Exchange

This product must be carried in for an exchange.

WHO IS COVERED?

You must have proof of purchase to exchange the product. A sales receipt or other document showing that you purchased the product is considered proof of purchase. Attach it to this owner's manual and keep both nearby.

WHAT IS COVERED?

Warranty coverage begins the day you buy your product. For one year thereafter, a defective or inoperative product will be replaced with a new, renewed, or comparable product at no charge to you. A replacement product is covered only for the original warranty period. When the warranty on the original product expires, the warranty on the replacement product also expires.

WHAT IS EXCLUDED?

Your warranty does not cover:

- labor charges for installation or setup of the product, adjustment of customer controls on the product, and installation or repair of antenna systems outside of the product.
- product repair and/or part replacement because of misuse, accident, unauthorized repair or other cause not within the control of Magnavox.
- reception problems caused by signal conditions or cable or antenna systems outside the unit.
- a product that requires modification or adaptation to enable it to operate in any country other than the country for which it was designed, manufactured, approved and/or authorized, or repair of products damaged by these modifications.
- incidental or consequential damages resulting from the product. (Some states do not allow the exclusion of incidental or consequential damages, so the above exclusion may not apply to you. This includes, but is not limited to, prerecorded material, whether copyrighted or not copyrighted.)
- a product that is used for commercial or institutional purposes.

WHERE IS EXCHANGE AVAILABLE?

You may exchange the product in all countries where the product is officially distributed by Magnavox. In countries where Magnavox does not distribute the product, the local Magnavox service organization will attempt to provide a replacement product (although there may be a delay if the appropriate product is not readily available).

BEFORE REQUESTING EXCHANGE...

Please check your owner's manual for assistance. If you have additional questions, call us at 1-800-705-2000.

EXCHANGING A PRODUCT IN U.S.A., PUERTO RICO, OR U.S. VIRGIN ISLANDS...

Contact Magnavox to arrange an exchange.

Please call 1-800-705-2000 to arrange an exchange.

(In U.S.A., Puerto Rico, and U.S. Virgin Islands, all implied warranties, including implied warranties of merchantability and fitness for a particular purpose, are limited in duration to the duration of this express warranty. But, because some states do not allow limitations on how long an implied warranty may last, this limitation may not apply to you.)

EXCHANGING A PRODUCT IN CANADA...

Please contact Magnavox at:

1-800-661-6162 (French Speaking)

1-800-705-2000 (English Speaking or Spanish Speaking)

(In Canada, this warranty is given in lieu of all other warranties. No other warranties are expressed or implied, including any implied warranties of merchantability or fitness for a particular purpose. Magnavox is not liable under any circumstances for any direct, indirect, special, incidental or consequential damages, howsoever incurred, even if notified of the possibility of such damages.)

REMEMBER...

Please record below the model and serial numbers found on the product. Also, please fill out and mail your warranty registration card promptly. It will be easier for us to notify you if necessary.

MODEL # _____

SERIAL # _____

This warranty gives you specific legal rights. You may have other rights which vary from state/province to state/province.

Magnavox, P.O. Box 520890, Miami, FL 33152 (402) 536-4171

EL6519E002 / 3-03